

**KWC**

Swiss Water Experience

KWC  
**ZOE**





# Art in Motion



KWC ZOE adds a distinctive personal touch to your bathroom. Beneath its gentle, sculptural surface, this new faucet contains innovative technologies that offer tangible benefits. With its unique shape, it embodies the purity of a natural spring and demonstrates a flair for simple design. KWC ZOE is equally at home in private residences as in hotels and restaurants.

**Intuitive and exclusive**

KWC ZOE's graceful yet ergonomically robust lever with a shortened pin blends discreetly and elegantly into the overall interior design of your bathroom. It also allows you to control the flow rate and water temperature easily and intuitively, leaving your hands as free as possible.

**Safe and sound**

KWC ZOE particularly proves its worth in households where small children are around. Cold water flows when the lever is pointing forward and mixed water runs when it is in the central position, keeping guests of all ages safe from scalding in the bathroom.





# Elegance in its finest form



KWC ZOE is as stylish as it is flexible. It fits in perfectly with any bathroom design concept. Wherever you put it, this graceful faucet leaves your hands plenty of room for manoeuvre, taking convenience to a whole new level.



**Brimming over with brilliance**

KWC ZOE offers you plenty of scope for creativity when it comes to bathtub design. There are various faucet components to choose from and you can opt for either a concealed or a surface-mounted solution, whichever you prefer.

Whether it is on a basin or a bidet, in the shower or on the bath, KWC ZOE cuts a fine figure wherever it goes. This faucet line's extensive product range is sure to offer the perfect choice for you.





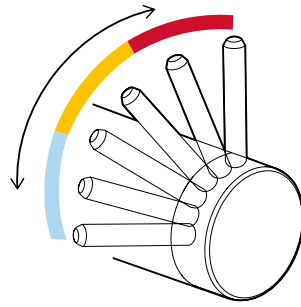
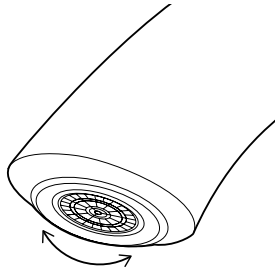

**Neoperl® Caché® SSR E**

Thanks to the Neoperl® Caché® SSR E jet regulator integrated into the spout, the direction and angle of the jet of water from side-operated basin faucets can be adjusted as required – if the water is hitting the basin at an inconvenient angle, for instance, thereby making it difficult to wash your hands.

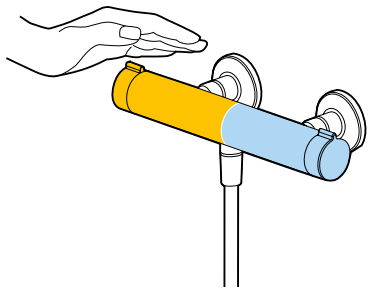

**Controlling the temperature**

KWC ZOE particularly proves its worth in households where small children are around. Cold water flows when the lever is pointing forward and mixed water runs when it is in the central position, keeping guests of all ages safe from scalding in the bathroom.

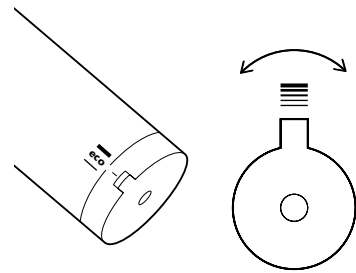
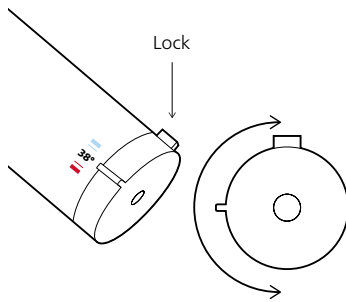

**touchcontrol** (on thermostats only)

This water guidance system with its 'double skin' principle ensures that users are never burned by their KWC faucet. The insulated hot water supply keeps the body of the faucet warm without letting it get too hot.

**hotcontrol** (on thermostats only)

Faucets with hotcontrol technology only supply water at temperatures above 38° C if the safety button on the temperature controller has been pressed deliberately. If the cold water supply fails, the hot water flow is automatically stopped immediately.

**smartcontrol** (on thermostats only)

smartcontrol keeps an eye on water consumption. Tangible resistance in the turning handle limits the amount of outflowing water. To switch off the economy mode, twist the handle back past the catch point.



**Basin**

Lever mixer

- Lever installation only possible on the right side
- Child safety: cold water flow in lever position towards the front
- Swivel spout 90°

**12.208.131.000FL** all chrome  
A 150, with pop-up valve  
**12.208.141.000FL** all chrome  
A 150, without pop-up valve

Flow rate 6 l/min (3 bar)

**Basin**

Two-handle mixer

- 3-hole
- Swivel spout 90°

**12.203.151.000FL** all chrome  
A 150, with pop-up valve  
**12.203.161.000FL** all chrome  
A 150, without pop-up valve

Flow rate 6 l/min (3 bar)

**Basin**

Lever mixer

- Fixed spout

**11.202.033.000** all chrome  
A 175, Trim kit  
**11.202.034.000** all chrome  
A 225, Trim kit

**To be ordered separately:**  
Unit for concealed installation ½"  
**39.193.400.931**

Flow rate 5 l/min (3 bar)

**Bidet**

Lever mixer

- Lever installation only possible on the right side
- Fixed spout
- ball joint aerator Neoperl® Caché®

**13.201.041.000FL** all chrome  
A 100, with pop-up valve

Flow rate 5 l/min (3 bar)

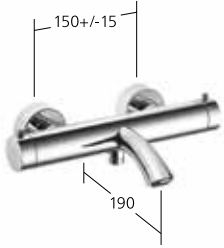
**Tub**

Thermostatic mixer

- smartcontrol – water-saving device
- touchcontrol – the body of the mixer does not become hot
- hotcontrol – temperature handle with safety stop button 38° C
- Fixed spout

**20.202.503.000** all chrome  
AD 150 +/- 15 mm, A 190, without hand shower and hose

Flow rate 20 l/min (3 bar)

Spray outlet:  
Flow rate 14 l/min (3 bar)

**Tub**

Trim kit with function unit  
– Outflow top and below

**20.204.580.000** all chrome  
Trim kit

**20.204.590.000** all chrome  
Trim kit, with vacuum breaker  
DIN EN 1717

**To be ordered separately:**  
Unit for concealed installation  
KWC VAROX 1/2" **39.999.300.931**,  
with shut-off valves

Flow rate 21 l/min (3 bar)

**Tub**

Trim kit with thermostatic function unit  
– Outflow top and below

**20.204.480.000** all chrome  
Trim kit

**To be ordered separately:**  
Unit for concealed installation  
KWC VAROX 1/2" **39.999.300.931**,  
with shut-off valves

Flow rate 21 l/min (3 bar)

**Accessories**

Bathtub spout  
– Fixed spout

**26.201.073.000** all chrome  
A 200

Flow rate 28 l/min (3 bar)

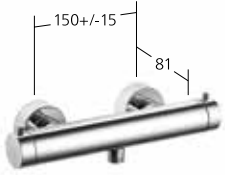

### Shower

Thermostatic mixer

- smartcontrol – water-saving device
- touchcontrol – the body of the mixer does not become hot
- hotcontrol – temperature handle with safety stop button 38° C

**21.202.500.000** all chrome  
AD 150 +/- 15 mm, without hand shower and hose

Spray outlet:  
Flow rate 14 l/min (3 bar)



### Shower

Trim kit with function unit  
– Outflow top or below

**21.204.580.000** all chrome  
Trim kit

**To be ordered separately:**  
Unit for concealed installation  
KWC VAROX ½" **39.999.300.931**,  
with shut-off valves

Flow rate 21 l/min (3 bar)



### Shower

Trim kit with thermostatic function unit  
– Outflow top or below

**21.204.480.000** all chrome  
Trim kit

**To be ordered separately:**  
Unit for concealed installation  
KWC VAROX ½" **39.999.300.931**,  
with shut-off valves

Flow rate 21 l/min (3 bar)





# Icon with style







With KWC ZOE, you can channel our 140 years of expertise in working with water into your kitchen in the form of a sculptural masterpiece. This faucet combines clever functions with a captivating interplay of light and water and the distinctive hallmark of a master in unparalleled perfection. In short, KWC ZOE brings a whole new level of luxury to your kitchen.

**On and off**

A touch of a button is all it takes for luminaqua® to transform the jet of water from your faucet into a wonderful play of light. The light switches off automatically after 30 minutes.



# Evocative and enduring



### **Subtle yet powerful**

The elegant yet robust operating lever blends discreetly into the background thanks to its dark-coloured design, but its functional qualities soon come to the fore: the flow rate and water temperature can be controlled extremely intuitively and with tactile, comfortable ease.

### **Safe and sound**

KWC ZOE particularly proves its worth in households where small children are around. Cold water flows when the lever is pointing forward and mixed water runs when it is in the central position, keeping guests of all ages safe from scalding in the kitchen.







# A distinctive masterpiece

KWC ZOE reveals new aspects of its unmistakable character from every angle, making it a style icon pioneering completely new approaches to faucet design.



## **Colours and styles**

All of the latest trends in architecture and interior design have been incorporated into the development of KWC ZOE, while new finishes add the final touch to the range: this premium product is now available with a classic black, an elegant glacier white surface or with a 'decor steel' stainless steel effect. This array of colours makes KWC ZOE ideal for a wide range of applications to suit all kinds of different lifestyles.

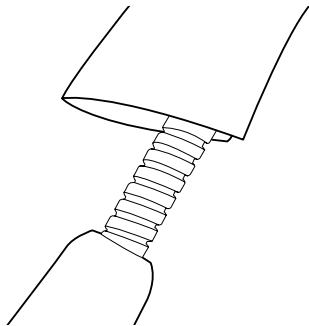

### Pull-out spray

The spray is seamlessly integrated into the spout and can be extended up to 50 cm. A high-quality metallic casing extends the service life of the pull-out hose.

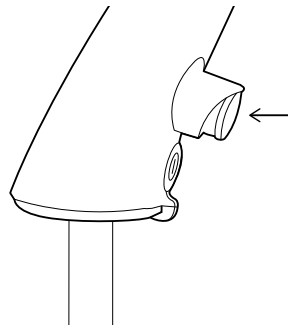

### Diverter

Just one press of the diverter button on the shower head is all it takes to switch from a full Neoperl® spray to a fine needle spray.

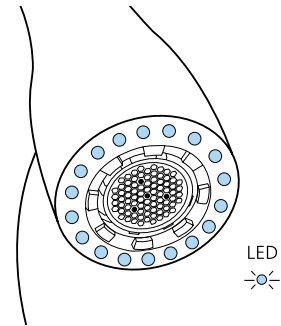

### luminaqua®

To create the right atmosphere in your kitchen, you can activate the luminaqua® play of light whenever the mood strikes you. The light ring is integrated into the pull-out aerator, making it seem invisible, while the LEDs have a very long lifespan but use very little electricity.

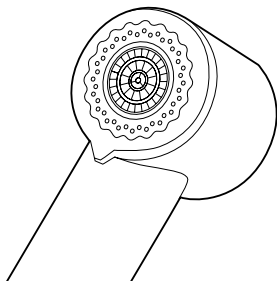

### jetclean

The jetclean faceplate prevents limescale from building up on your kitchen spray and does some of your cleaning work for you. When water is flowing, the cone-shaped holes on the faceplate expand, dislodging any stubborn limescale deposits. The holes go back to their normal size when the water flow is switched off.

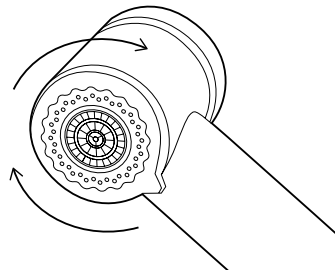

### turn and clean (tac)

If limescale deposits build up on the faceplate of your faucet, the turn and clean fastening mechanism will come to your aid: simply turn, clean and the job is done.

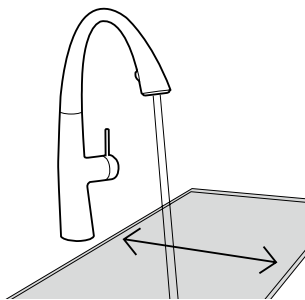

For an angled spray of water, the size of the basin must be factored in.

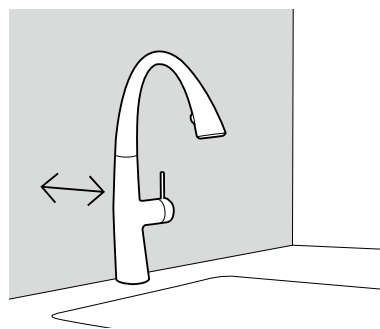

When installing faucets, the distance from the wall must be taken into account. Approximately 55 mm between the wall and the centre of the faucet.

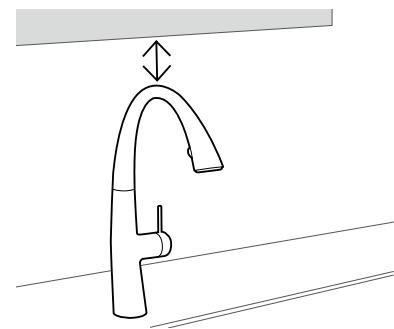

Windows / wall units need to be taken into account.





**10.201.122.000FL** all chrome  
A 215, mains receiver, with luminaqua®  
LED-technology  
**10.201.102.000FL** chromeline  
A 215



**10.201.122.127FL** decor steel  
A 215, mains receiver, with luminaqua®  
LED-technology  
**10.201.102.127FL** decor steel  
A 215



**10.201.122.106FL** black  
A 215, mains receiver, with luminaqua®  
LED-technology  
**10.201.102.106FL** black  
A 215



**10.201.122.150FL** glacier white  
A 215, mains receiver, with luminaqua®  
LED-technology  
**10.201.102.150FL** glacier white  
A 215

with luminaqua® LED-technology

Lever mixer

- Lever installation only possible on the right side
- Child safety: cold water flow in lever position towards the front
- Covered pull-out spray
- ergonomic spout alignment, shape and handling
- KWC-jetclean-technology
- automatic diverter reset
- integrated ON/OFF push-button with automatic shut-off after 30 minutes
- up to 500 mm pull-out length
- hose surface to fit faucet surface
- Hose guide, swivelling 270°

Flow rate normal spray 8 l/min (3 bar)  
Flow rate needle spray 9 l/min (3 bar)

without luminaqua® LED-technology

Lever mixer

- Lever installation only possible on the right side
- Child safety: cold water flow in lever position towards the front
- Covered pull-out spray
- ergonomic spout alignment, shape and handling
- KWC-jetclean-technology
- automatic diverter reset
- up to 500 mm pull-out length
- hose surface to fit faucet surface
- Hose guide, swivelling 270°

Flow rate normal spray 8 l/min (3 bar)  
Flow rate needle spray 9 l/min (3 bar)



**Z.536.586.000** all chrome



**Z.536.586.127** decor steel



**Z.536.586.106** black



**Z.536.586.150** glacier white

